

Godox 神牛

TTL 锂电机顶闪光灯

Pioneering TTL Li-ion Camera Flash

V860 II C

For Canon

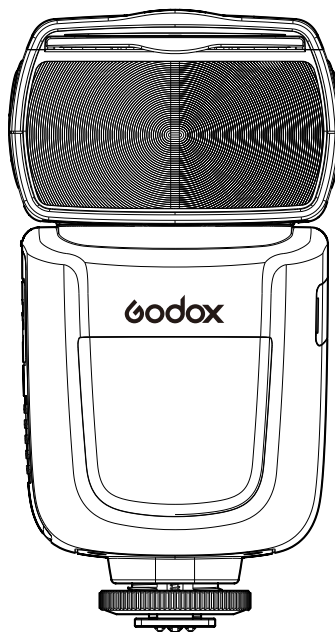

INSTRUCTION MANUAL
说明书

中英文双语 / Chinese English Bilingual

深圳市神牛摄影器材有限公司

GODOX Photo Equipment Co., Ltd.

地址/Add: 深圳市宝安区福海街道塘尾社区耀川工业区厂房2栋1层至4层、4栋1层至4层
1st to 4th Floor, Building 2/ 1st to 4th Floor, Building 4, Yaochuan Industrial Zone,
Tangwei Community, Fuhai Street, Bao'an District, Shenzhen 518103, China
电话/Tel: +86-755-29609320(8062) 传真/Fax: +86-755-25723423
邮箱/E-mail: godox@godox.com http://www.godox.com

705-V8602C-00

Made In China



在使用本产品之前：

请先仔细阅读本手册，以确保您能安全使用。请保存好本手册以备将来查询参考。

Before using this product:

Please read this user manual carefully in order to ensure your safety and the proper operation of this product. Keep for future reference.

固件升级

本机通过USB插座可进行固件升级。软件最新公告及说明将会发布在官方网站上。

注：本品出厂不配USB升级线，请另行购买。普通的USB线可使用，本产品USB口为Micro USB 接口。

兼容相机列表

本机可兼容以下佳能EOS系列的相机型号：

1DX	5D Mark III	5D Mark II	6D	7D	60D	50D	40D	30D
650D	600D	550D	500D	450D	400D Digital	1100D	1000D	

注：

1. 此表格仅列举目前已测试的相机型号，未涵盖所有佳能EOS系列相机。其他相机型号，用户可自行测试。
2. 本公司保留未来修改此表格内容的权利。

维护保养

- 闪光灯在工作时，如发现异常，应立即关掉电源，查明原因。
- 灯体应避免震动，平时注意表面除尘。
- 灯体稍有发热为正常现象，无特别需要时，勿连续引闪。
- 闪光灯的所有维修概由本厂指定可供原厂配件之维修部负责。
- 1年保修，消耗品如灯管等，不在1年保修范围。
- 经发现，擅自检修此闪光灯的，将取消闪光灯之一年保修期，维修需要收取相关费用。
- 如果本品出现故障或者被水淋湿，在专业人员维修后方可继续使用。
- 如有技术更改，恕不另行通知。

Foreword

Thank you for purchasing this product.

This V860IIC camera flash applies to Canon EOS series cameras and is compatible with E-TTL II autoflash. With this E-TTL II compatible flash, your shooting will become simpler. You can easily achieve a correct flash exposure even in complex light-changing environments. This camera flash features:

- GN60 (m ISO 100, @200mm). 22 steps from 1/1 to 1/128.
- Pro 2000mAh Li-ion Battery-max.1.5s recycle-650 full power pops.
- Fully support Canon E-TTL II camera flash. Workable as Master or Slave unit in a wireless flash group.
- Use dot-matrix LCD panel to make clear and convenient operations.
- With built-in 2.4GHz wireless remote system to support transmitting and receiving.
- Provided multiple functions, include HSS (up to 1/8000s), FEC, FEB, etc.
- Use optional FT-16S to adjust flash parameters & trigger the flash.
- Stable consistency and color temperature with good even lighting.
- Support with firmware upgrade.

⚠ warning

- ▲ Always keep this product dry. Do not use in rain or in damp conditions.
- ▲ Do not disassemble. Should repairs become necessary, this product must be sent to an authorized maintenance center.
- ▲ Keep out of reach of children.
- ▲ Stop using this product if it breaks open due to extrusion, falling or strong hit. Otherwise, electric shock may occur if you touch the electronic parts inside it.
- ▲ Do not fire the flash directly into the eyes (especially those of babies) within short distances. Otherwise visual impairment may occur.
- ▲ Do not use the flash unit in the presence of flammable gases, chemicals and other similar materials. In certain circumstance, these materials may be sensitive to the strong light emitting from this flash unit and fire or electromagnetic interference may result.
- ▲ Do not leave or store the flash unit if the ambient temperature reads over 50°C. Otherwise the electronic parts may be damaged.
- ▲ Turn off the flash unit immediately in the event of malfunction.

Contents



Conventions used in this Manual

- This manual is based on the assumption that both the camera and camera flash's power switches are powered on.
- Reference page numbers are indicated by "p.***".
- The following alert symbols are used in this manual:
 - ▲ The Caution symbol gives supplemental information.
 - 📌 The Note symbol indicates a warning to prevent shooting problem.

42	Foreword
42	Warning
45	Name of Parts
	Body
	Control Panel
	Dot-matrix LCD Panel
	LCD Panel in Five Modes
	What's in the Box of V860IIC Kit?
	What's in the Box of V860IIC (only flash unit)?
	Separately Sold Accessories

49	Battery
50	Attaching to a Camera
50	Power Management
51	Flash Mode — E-TTL Autoflash
	📷 FEC (Flash Exposure Compensation)
	📷 FEB (Flash Exposure Bracketing)
	FEL: Flash Exposure Lock
	📷 High-Speed Sync
	📷 Second-Curtain Sync
54	M: Manual Flash
55	Multi: Stroboscopic Flash
56	Wireless Flash Shooting: Radio (2.4G) Transmission
	Wireless Settings
	Master Unit's Flash OFF
	Setting the Communication Channel
	Wireless ID Settings
	ETTL: Fully Automatic Wireless Flash Shooting
	ETTL: Use the Wireless Flash Shooting of Flash Ratio
	M: Wireless Flash Shooting with Manual Flash
	Multi: Wireless Flash Shooting with Manual Flash
	Gr: Shooting with a Different Flash Mode for Each Group
67	Wireless Flash Shooting: Optic Transmission
	Wireless Settings
	Master Unit's Flash OFF
	Setting the Communication Channel
	ETTL: Fully Automatic Wireless Flash Shooting
	ETTL: Use the Wireless Flash Shooting of Flash Ratio
	M: Wireless Flash Shooting with Manual Flash
	Multi: Wireless Flash Shooting with Manual Flash
74	Other Applications
	Wireless Control Function
	Sync Triggering
	Modeling Flash
	Auto Focus Assist Beam
	Bounce Flash
	Creating a Catchlight
	ZOOM: Setting the Flash Coverage and Using the Wide Panel
	Low Battery Indicator
77	C.Fn: Setting Custom Functions
78	Control with the Camera's Menu Screen
79	Protection Function
80	Technical Data
81	Troubleshooting
82	Firmware Upgrade
82	Compatible Camera Models
82	Maintenance

Name of Parts

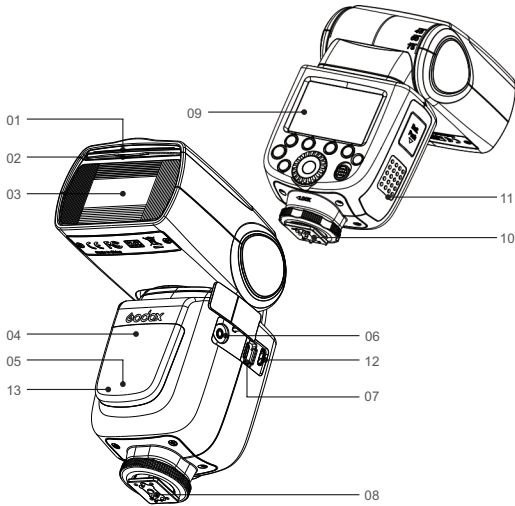

• Body

- | | |
|---------------------------|---------------------------------|
| 01. Catchlight Panel | 08. Hotshoe |
| 02. Built-in Wide Panel | 09. Dot-matrix LCD Panel |
| 03. Flash Head | 10. Lock Ring |
| 04. Optic Control Sensor | 11. Battery Compartment |
| 05. Focus Assist Beam | 12. USB Port |
| 06. Sync Cord Jack | 13. Slave Flash Ready Indicator |
| 07. Wireless Control Port | |

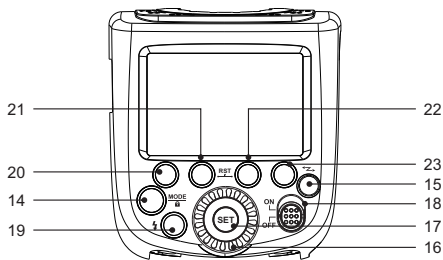

• Control Panel

- | | |
|--|---|
| 14. <MODE> Mode Selection Button / Lock button | 19. <⚡> Test Button / Flash Ready Indicator |
| 15. <*> Wireless Selection Button | 20. Function Button 1 |
| 16. Select Dial | 21. Function Button 2 |
| 17. <SET> Set Button | 22. Function Button 3 |
| 18. ON/OFF Power Switch | 23. Function Button 4 |

• LCD Panel

(1) E-TTL Autoflash

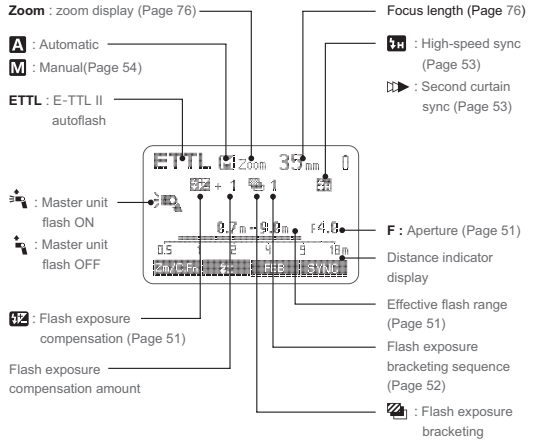

- The display will only show the settings currently applied.
- The functions displayed above function buttons 1 to 4, such as **SYNC** and **⚡**, change according to settings' status.
- When a button or dial is operated, the LCD panel illuminated.

(2) Manual Flash

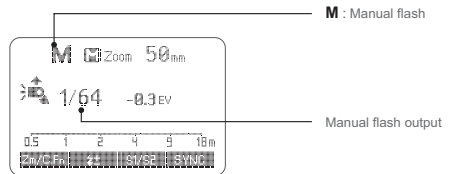

(3) Multi Flash

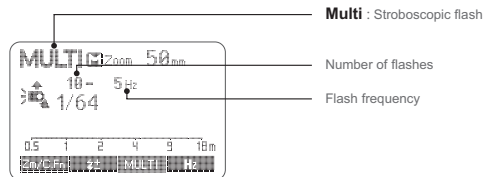

(4) Radio Transmission Shooting/Optic Transmission Shooting

• Master Unit

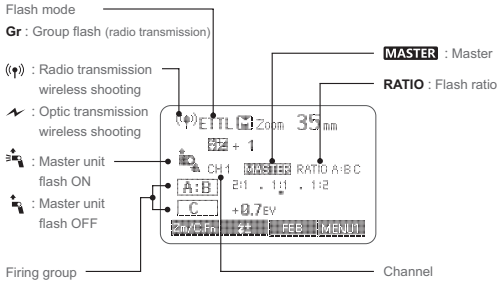

• Slave Unit

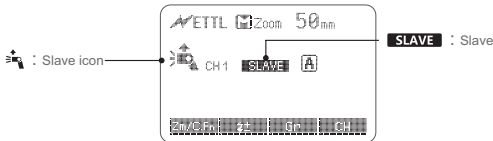

• LCD Panel in Five Modes

• Attached to the Camera

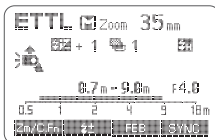

• Optical Transmission: As a Master Unit

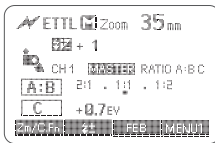

• Optical Transmission: As a Slave Unit



• 2.4G Radio Transmission: As a Master Unit



• 2.4G Radio Transmission: As a Slave Unit



• What's in the Box of V860IIC Kit?

1. Flash Unit
2. Li-ion Battery Pack
3. Battery Charger
4. Battery Charger Cable
5. Mini Stand
6. Protection Case
7. Instruction Manual

• What's in the Box of V860IIC (only flash unit)?

1. Flash Unit
5. Mini Stand
6. Protection Case
7. Instruction Manual



● Separately Sold Accessories

The product can be used in combination with the following accessories sold separately, so as to achieve best photography effects:

X1C TTL wireless flash trigger, FT-16S power & trigger control, Mini softbox, White & Silver reflector, Honeycomb, Color gels, Snoot, etc.



Battery

● Features

1. This flash unit uses Li-ion polymer battery which has long runtime. The available charge-and-discharge times are 500.
2. It is reliably safe. The inner circuit is against overcharge, overdischarge, overcurrent, and short circuit.
3. Take only 2.5 hours to fully charge the battery by using the standard battery charger.

● Cautions

1. Do not short circuit.
2. Do not expose to rain or immerse into water. This battery is not water proof.
3. Keep out of reach of children.
4. No over 24 hours' continuous charging.
5. Store in dry, cool, ventilated places.
6. Do not put aside or into fire.
7. Dead batteries should be disposed according to local regulations.
8. If the battery had ceased using for over 3 months, please make a full recharge.

● Loading and Unloading the Battery

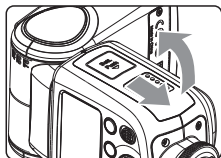

- 1 To load the battery, push the battery compartment cover downward and open it.

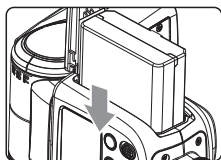

- 2 According to the triangle sign on the battery pack, insert it into the compartment until a white knob locks the battery with a click sound.

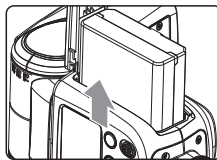

- 3 To unload the battery, tap the white knob and the battery pack will pop out. Then close the compartment.

● Battery Level Indication

Make sure the battery pack is securely loaded in the flash. Check the battery level indication on the LCD panel to see the remaining battery level.

Battery Level Indication	Meaning
3 grids	Full
2 grids	Middle
1 grid	Low
Blank grid	Lower battery, please recharge it.
Blinking	The battery level is going to be used out immediately. And the flash will auto power off in 1 minute. Note: Please recharge the battery as soon as possible (within 10 days). Then, the battery can be used or be placed for long period.

Attaching to a Camera

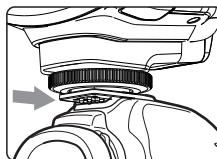

- 1 Attach the Camera Flash.
 - Slip the camera flash's mounting foot into the camera's hotshoe all the way.

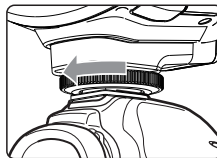

- 2 Secure the Camera Flash.
 - Rotate the lock ring on the mounting foot until it locks up.

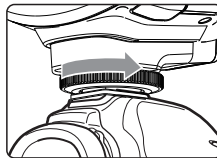

- 3 Detach the Camera Flash.
 - Rotate the lock ring on the mounting foot until it is loosened.

Power Management

Use ON/OFF Power Switch to power the flash unit on or off. Turn off if it will not be used for an extended period of time. Setting as a master flash, it will turn the power off automatically after a certain period (approx. 90 seconds) of idle use. Pressing the camera shutter halfway or pressing any flash button will wake up the flash unit. Setting as a slave flash, it will enter sleep mode after a certain period (adjustable, 60 minutes by default) of idle use. Pressing any flash button will wake it up.

- C.Fn** Disabling Auto Power Off function is recommended when the flash is used off camera. (C.Fn-APO, Page 77)
- C.Fn** Slave Auto Power Off Timer is set to 60 minutes by default. Another option "30 minutes" is available. (C.Fn-Sv APOT, Page 77)

Flash Mode—E-TTL Autoflash

This flash has three flash modes: **E-TTL**, **Manual (M)**, and **Multi** (Stroboscopic). In **E-TTL** mode, the camera and the flash will work together to calculate the correct exposure for the subject and the background. In this mode, multiple TTL functions are available: FEC, FEB, FEL, HSS, second curtain sync, modeling flash, control with the camera's menu screen.

* Press **<MODE>** Mode Selection Button and three flash modes will display on the LCD panel one by one with each pressing.

E-TTL Mode

Press **<MODE>** Mode Selection Button to enter E-TTL mode. The LCD panel will display.

- Press the camera release button halfway to focus. The aperture and effective flash range will be displayed in the viewfinder.
- When the shutter button is fully pressed, the flash will fire a pre-flash that the camera will use to calculate exposure and flash output the instant before the photo is taken.

FEC: Flash Exposure Compensation

With FEC function, this flash can adjust from -3 to +3 in 1/3rd stops. It is useful in situations where minor adjusting of the TTL system is needed based on the environment.

Setting FEC:

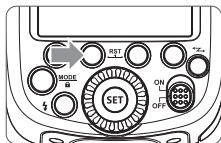

- Press Function Button 2 **< +/- >**. The icon **< +/- >** and flash exposure compensation amount will be highlighted on the LCD panel.

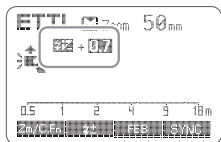

- Set the flash exposure compensation amount.
 - Turn the Select Dial to set the amount.
 - "0.3" means 1/3 step, "0.7" means 2/3 step.
 - To cancel the flash exposure compensation, set the amount to "+0".

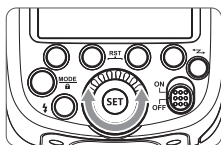

- Press **<SET>** button again to confirm the setting.

FEB: Flash Exposure Bracketing

You can take three flash shots while automatically changing the flash output for each shot from -3 to +3 in 1/3rd stops. The camera will record three images with different exposures: one exposed according to camera calculations, one over-exposed and another under-exposed. Over and under exposure amount is user adjustable. This function helps get correct exposure especially in shooting moving objects or when environmental lights are complex.

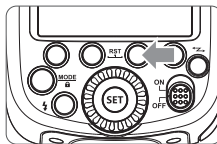

- Press function button 3 **< FEB >**. The icon **< +/- >** and the exposure bracketing amount will be highlighted on the LCD panel.

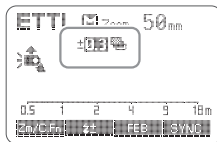

- Set the flash exposure compensation amount.
 - Turn the Select Dial to set the amount.
 - "0.3" means 1/3 step, "0.7" means 2/3 step.

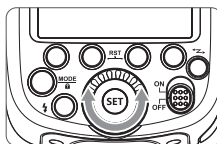

- Press **<SET>** button again to confirm the setting. Then your **FEC** and **FEB** settings are displayed on the LCD panel.

- FEB** will be cancelled after three photos are taken.
 - For best results, set the camera drive mode to "single" and ensure the flash is ready before shooting.
 - FEB** can be used with **FEC** and **FEL**.
- C.Fn** You can prevent the FEB from being cancelled automatically after three photos are taken. (C.Fn-FEB ACL, Page 77)
- C.Fn** The FEB shooting sequence can be changed. (C.Fn-FEB, Page 77)

FEL: Flash Exposure Lock

FEL can lock the correct flash exposure setting for any part of the scene.

With **<ETTL>** displayed on the LCD panel, press the camera's **<FEL>** button. If the camera does not have the **<FEL>** button, press the **<* >** button.

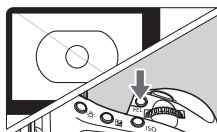

- Focus the subject.
- Press the **<FEL>** button.
 - Aim the subject at the center of the viewfinder and press **<FEL>** button.
 - The camera flash will fire a preflash and the required flash output for the subject is retained in memory.
 - Each time the **<FEL>** button is pressed, a preflash will be fired and a new flash exposure setting will be locked.

- If the subject is too far away and underexposure, the < \downarrow > icon will blink in the viewfinder. Move closer to the subject and try the FE lock again.
- If < E TTL > is not displayed on the LCD panel, FE lock cannot be set.
- If the subject is too small, FE lock might not be very effective.

High-Speed Sync

High Speed Sync (FP flash) enables the flash to synchronize with all camera shutter speeds. This is convenient when you want to use aperture priority for fill-flash portraits.

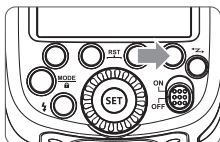

- 1 Press Function Button 2 < SYNC > so that < \downarrow > is displayed.

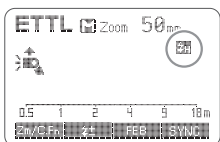

- 2 Check that < \downarrow > is displayed in the viewfinder.

- If you set a shutter speed that is the same as or slower than the camera's maximum flash sync speed, < \downarrow > will not be displayed in the viewfinder.
- With high-speed sync, the faster the shutter speed, the shorter the effective flash range.
- To return to normal flash, press < SYNC > button again. Then < \downarrow > will disappear.
- Multi flash mode cannot be set in high-speed sync mode.
- Over-temperature protection may be activated after 15 consecutive high-speed sync flashes.

Second-Curtain Sync

With a slow shutter speed, you can create a light train following the subject. The flash fires right before the shutter closes.

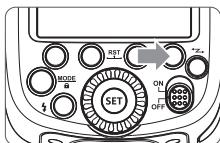

- Press function button 4 < SYNC > button so that < \Rightarrow > is displayed on the LCD panel.

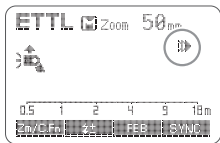

M: Manual Flash

The flash output is adjustable from 1/1 full power to 1/128th power in 1/3rd stop increments. To obtain a correct flash exposure, use a hand-held flash meter to determine the required flash output.

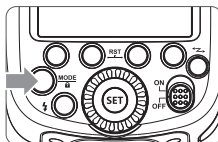

- 1 Press < MODE > button so that < M > is displayed.

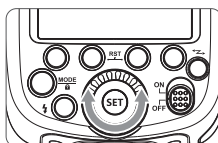
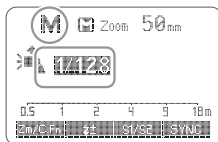

- 2 Turn the Select Dial to choose a desired flash output amount.
- 3 Press < SET > button again to confirm the setting.

Flash Output Range

The following table makes it easier to see how the stop changes in terms of f/stop when you increase or decrease the flash output. For example, when you decrease the flash output to 1/2, 1/2-0.3, or 1/2-0.7, and then increase the flash output to more than 1/2, 1/2+0.3, 1/2+0.7, and 1/1 will be displayed.

Figures displayed when reducing flash output level→

1/1	1/1-0.3	1/1-0.7	1/2	1/2-0.3	1/2-0.7	1/4
	1/2+0.7	1/2+0.3		1/4+0.7	1/4+0.3	

← Figures displayed when increasing flash output level

Optic S1 Secondary Unit Setting

In M manual flash mode, press < S1/S2 > button so that this flash can function as an optic S1 secondary flash with optic sensor. With this function, the flash will fire synchronously when the main flash fires, the same effect as that by the use of radio triggers. This helps create multiple lighting effects.

Optic S2 Secondary Unit Setting

Press < S1/S2 > button so that this flash can also function as an optic S2 secondary flash with optic sensor in M manual flash mode. This is useful when cameras have pre-flash function. With this function, the flash will ignore a single "pre-flash" from the main flash and will only fire in response to the second, actual flash from the main unit.

- S1 and S2 optic triggering is only available in M manual flash mode.

Multi: Stroboscopic Flash

With stroboscopic flash, a rapid series of flashes is fired. It can be used to capture a multiple images of a moving subject in a single photograph.

You can set the firing frequency (number of flashes per sec. expressed as Hz), the number of flashes, and the flash output.

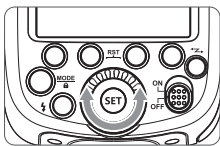
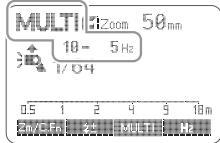
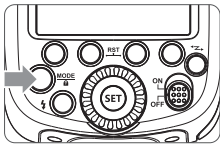

- 1 Press <MODE> button so that <MULTI> is displayed.
- 2 Turn the Select Dial to choose a desired flash output.
- 3 Set the flash frequency and flash times.
 - Press <MULTI> button to select the item (blinks).
 - Turn the Select Dial to set the number and press <Hz> button again to confirm. The next item to be set will blink.
 - After you finish the setting, press <SET> button and all the settings will be displayed.

Calculating the Shutter Speed

During stroboscopic flash, the shutter remains open until the firing stops. Use the formula below to calculate the shutter speed and set it with the camera.

$$\text{Number of Flashes} / \text{Flash Frequency} = \text{Shutter Speed}$$

For example, if the number of flashes is 10 and the firing frequency is 5 Hz, the shutter speed should be at least 2 seconds.

- ⚠ To avoid overheating and deteriorating the flash head, do not use stroboscopic flash more than 10 times in succession. After 10 times, allow the camera flash to rest for at least 15 minutes. If you try to use the stroboscopic flash more than 10 times in succession, the firing might stop automatically to protect the flash head. If this happens, allow at least 15 minutes' rest for the camera flash.

- 📌 • Stroboscopic flash is most effective with a highly reflective subject against a dark background.
- Using a tripod and a remote control is recommended.
- A flash output of 1/1 and 1/2 cannot be set for stroboscopic flash.
- Stroboscopic flash can be used with "buLb".
- If the number of flashes is displayed as "--", the firing will continue until the shutter closes or the battery is exhausted. The number of flashes will be limited as shown by the following table.

Maximum Stroboscopic Flashes:

Flash output \ Hz	1	2	3	4	5	6-7	8-9
1/4	7	6	5	4	4	3	3
1/8	14	14	12	10	8	6	5
1/16	30	30	30	20	20	20	10
1/32	60	60	60	50	50	40	30
1/64	90	90	90	80	80	70	60
1/128	100	100	100	100	100	90	80

Flash output \ Hz	10	11	12-14	15-19	20-50	60-199
1/4	2	2	2	2	2	2
1/8	4	4	4	4	4	4
1/16	8	8	8	8	8	8
1/32	20	20	20	18	16	12
1/64	50	40	40	35	30	20
1/128	70	70	60	50	40	40

If the number of flashes is displayed as "--", the maximum number of flashes will be as shown in the following table regardless of the flash frequency.

Flash Output	1/4	1/8	1/16	1/32	1/64	1/128
Number of Flashes	2	4	8	12	20	40

Wireless Flash Shooting: Radio (2.4G) Transmission

- ⚠ • When the camera's shooting mode is set to a fully automatic mode or an Image Zone mode, the operations in this chapter are not available. Set the camera's shooting mode to P/Tv/Av/M/B (Creative Zone Mode).
- 📌 • The V860IIC attach to the camera is called the master unit, and a V860IIC that is wirelessly controlled is called the slave unit.
 - You can also wirelessly control the V860IIC set as the slave unit with the transmitter X1T-C (sold separately). For details on setting the master unit functions, see the transmitter's instructions.

Using a flash (master/slave) with a radio transmission wireless shooting function make it easy to shoot with advanced wireless multiple flash lighting, in the same way as E-TTL II autoflash shooting.

The basic relative position and operation range are as shown in the picture. You can then perform wireless E-TTL II autoflash shooting just by setting the master unit to <ETTL>.

Positioning and Operation Range (Example of wireless flash shooting)

• Autoflash Shooting with One Slave Unit

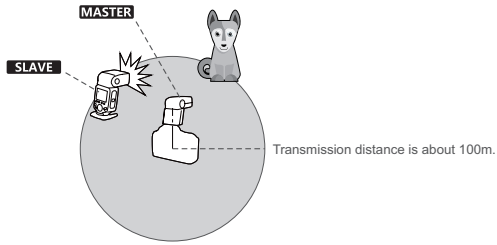

- Use the supplied mini stand to position the slave unit.
- Before shooting, perform a test flash and test shooting.
- The transmission distance might be shorter depending on the conditions such as positioning of slave units, the surrounding environment and whether conditions.

Wireless Multiple Flash Shooting

You can divide the slave units into two or three groups and perform E-TTL II autoflash while changing the flash ratio (factor). In addition, you can set and shoot with a different flash mode for each firing group, for up to 5 groups.

• Auto Shooting with Two Slave Groups

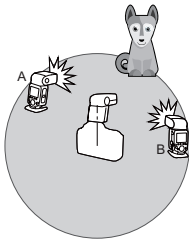

• Auto Shooting with Three Slave Groups

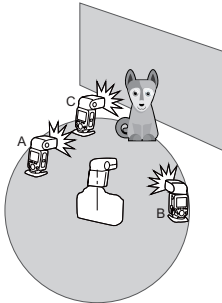

• Shooting with a Different Flash Mode set for Each Group

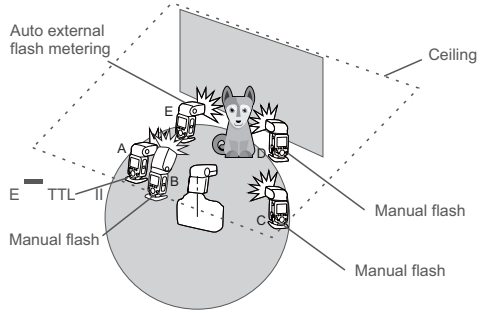

* The flash mode settings are indicated only as an example

Wireless shooting using radio transmission has advantages over wireless shooting using optic transmission, such as being less affected by obstacles, and not having to point the slave unit's wireless sensor toward the master unit. The main functional differences are as follows:

Function	Radio Transmission	Optic Transmission
Distance	100m	15m
Channel	1~32	1~4
A/B/C Power	OFF, 1/128~1/1	1/128~1/1
To be Disturbed	Hard	Easy
Group	A/B/C/D/E	A/B/C

- There are four flash modes in this wireless radio transmission: TTL, M, Multi and Gr. Choose one of those modes by pressing the MODE Button.

▲ The Reason & Solution of Not Triggering in Godox 2.4G Wireless

- 1. Disturbed by the 2.4G signal in outer environment (e.g. wireless base station, 2.4G wifi router, Bluetooth, etc.)**
 → To adjust the channel CH setting on the flash trigger (add 10+ channels) and use the channel which is not disturbed. Or turn off the other 2.4G equipment in working.
- 2. Please make sure that whether the flash has finished its recycle or caught up with the continuous shooting speed or not (the flash ready indicator is lighten) and the flash is not under the state of over-heat protection or other abnormal situation.**
 →Please downgrade the flash power output. If the flash is in TTL mode, please try to change it to M mode(a preflash is needed in TTL mode).
- 3. Whether the distance between the flash trigger and the flash is too close or not**
 →Please turn on the "close distance wireless mode" on the flash trigger (< 0.5m):
 X1 series: press the test button and hold on, then turning it on until the flash ready indicator blinks for 2 times.
 XPro series: Set the C.Fn-DIST to 0-30m.
- 4. Whether the flash trigger and the receiver end equipment are in the low battery states or not**
 →Please replace the battery(the flash trigger is recommended to use 1.5V disposable alkaline battery).

1. Wireless Settings

You can switch between normal flash and wireless flash. For normal flash shooting, be sure to set the wireless setting to OFF.

Master Unit Setting

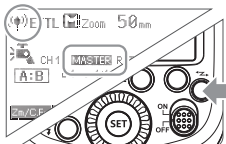

Press **<Fn>** button so that **<(Fn)>** or **<MASTER>** are displayed on the LCD panel.

Slave Unit Setting

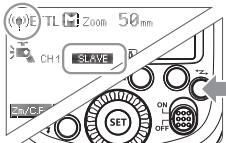

Press **<Fn>** button so that **<(Fn)>** or **<SLAVE>** are displayed on the LCD panel.

2. Master Unit's Flash OFF

When the master unit is set to OFF, only the slave units will fire a flash.

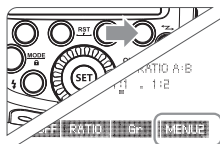

1 Press Function **Button 4** so that **<MENU2>** is displayed on the LCD panel.

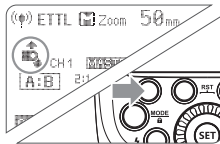

2 Press Function **Button 1** **<ON/OFF>** to control the ON/OFF of the master unit.

<Fn> : The master unit flash firing is ON.

<Fn> : The master unit flash firing is OFF.

- Even if the master unit flash firing is disabled, it still fires a preflash to transmit wireless signals.

3. Setting the Communication Channel

If there are other wireless flash systems nearby, you can change the channel IDs to prevent signal interference. The channel IDs of the master unit and the slave unit(s) must be set to the same.

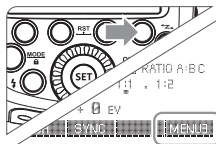

1 Press Function **Button 4** so that **<MENU3>** is displayed on the LCD panel.

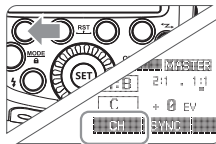

2 Press Function **Button 1** so that **<CH>** is displayed on the LCD panel. Turn the Select Dial to choose a channel ID from 1 to 4.

3 Press the **<SET>** button to confirm.

4. Wireless ID Settings

Change the wireless channels and wireless ID to avoid interference for it can only be triggered after the wireless IDs and channels of the master unit and the slave unit are set to the same. Press the **<MENU>** button to enter C.Fn ID. Press the **<SET>** button to choose OFF channel expansion shutdown, and choose any figure from 01 to 99.

5. E TTL: Fully Automatic Wireless Flash Shooting

Using Automatic Wireless Flash with a Single Slave Unit



1 Master Unit Setting

- Attach a V860IIC camera flash on the camera and set it as the master unit.
- X1T-C can also be used as master unit. X1T-C can control V860IIC's ZOOM value when the ZOOM is adjusted to auto (A) mode.



2 Slave Unit Setting

- Set the other camera flash as the wireless slave Unit.

3 Check the communication channel.

- If the master unit and slave unit(s) are set to a different channel, set them to the same channel. (Page 60)

4 Position the camera and flashes.

- Position the camera and flashes as the picture shows. (Page 57)

5 Set the master unit's flash mode to <ETTL>.

- Set the master unit's flash mode to <ETTL>.
- For shooting, <ETTL> will automatically be set for the slave unit.
- Set the master unit flash firing as ON to fire a flash.

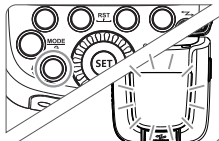

6 Check that the flash is ready.

- Check that the master flash ready indicator is lightened.
- When the slave flash ready indicator is ready, the AF-assist beam lighting area will blink at 1 second intervals.

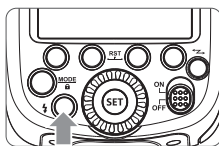

7 Check the flash operation.

- Press the master unit's Test Button < ⚡ >.
- Then, the slave unit will fire. If not, adjust the slave unit's angle toward the master unit and distance from the master unit.

Using Automatic Wireless Flash with Multiple Slave Units

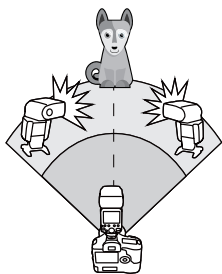

When stronger flash output or more convenient lighting operation is needed, increase the number of slave units and set it as a single slave unit.

To add slave units, use the same steps as setting "automatic wireless flash with a single slave unit". Any flash group can be set (A/B/C).

When the number of slave units is increased and the master unit flash firing is ON, automatic control is implemented to make all groups of flashes fire the same flash output and ensure the total flash output up is to standard exposure.

- Press the depth-of-field preview button on the camera to fire a modeling flash.
- If the slave unit's auto power off function is workable, press the master unit's test button to power it on. Please note that test firing is unavailable during the camera's regular metering time.
- The effective time of slave auto power off is changeable. (C.Fn-Sv APOT Page 77)
- By making some settings, the auto AF-assist transmitter will not blink after the slave unit's flash ready indicator is lightened. (C.Fn-AF Page 77)

Using Fully Automatic Wireless Flash

The FEC and other settings that set on the master unit will also be appeared on the slave unit automatically. The slave unit does not need any operation. Use the following settings to make wireless flashes according to the same methods with normal flash shooting.

- Flash Exposure Compensation (Page 51)
- Flash Exposure Bracketing (Page 52)
- Flash Exposure Lock (Page 52)
- High-Speed Sync (Page 53)
- Manual Flash (Page 54)
- Stroboscopic Flash (Page 55)

About Master Unit

Use two or more master units. By preparing several cameras that with master units flash attached, cameras can be changed in shooting while keeping the same lighting source (slave unit).

6. E TTL: Use the Wireless Shooting of Flash Ratio

Auto Flash Shooting with Two Slave Unit

Divide the slave units into A and B groups and balance their shooting illumination (flash ratio).

Auto control exposure to make the total output of A and B flash groups up to standard exposure.

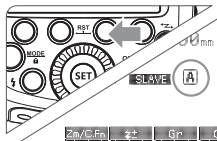

1 Setting the flash groups of slave unit.

- Set the flash as slave unit.
- Press Function Button 3 < Gr > and choose <A> or .
- Set one slave unit as <A>, the other as .

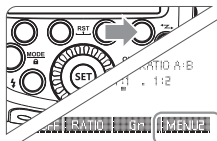

2 Setting < MENU 2 >.

- Step 2 to Step 4 are set on the master unit.
- Press the Function Button 4 on the master unit so that < MENU 2 > is displayed.

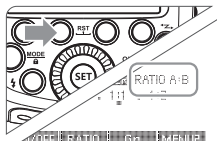

3 Setting <RATIO A:B>.

- Press Function Button 2 < RATIO > so that <RATIO A:B> is displayed.

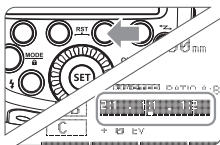

4 Setting flash ratio.

- Press Function **Button 3** < **Gr** >.
- Turn the Select Dial to set the amount of flash ratio and press-**SET**> button to confirm.

5 Taking the picture.

- The slave units will flash according to the flash ratio.

Auto Flash Shooting with Three Slave Unit

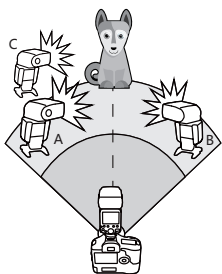

1 Setting the slave group <C>.

- Use the same method of step 1 (Page 62) to set the slave unit of flash group-<C>.

2 Setting <RATIO A:B C>.

- Use the same method of step 1 and step 3 (Page 62) to set the master unit as <RATIO A:B C>.

3 Setting flash exposure compensation.

- Use the same method of step 1 (Page 62) to set the slave unit of flash group-<C>.
- Press Function **Button 2** < **±** >. Turn the Select Dial to set the amount of flash exposure compensation and press-**SET**> button to confirm.

About Slave Group Control

Slave Group A

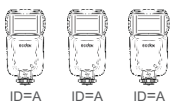

If three slave units are all set to <A> in terms of slave ID, these slave units will be controlled as if they were one camera flash in slave group A.

- ▲ When setting < RATIO A:B C >, group A, B and C will fire a flash synchronously; when setting< RATIO A:B >, group C will not fire a flash.
- If shooting under the situation that group C is toward the main shooting subject, over exposure might occurred.
- In some EOS film cameras that support E-TTL autofocus, you cannot perform multiple flash wireless shooting with a flash ratio setting.

- The flash ratio of 8:1 to 1:1 to 1:8 is equivalent to 3:1 to 1:1 to 1:3 (1/2 step increment).

- The details of the flash ratio settings are as follows.

8:1	4:1	2:1	1:1	1:2	1:4	1:8
5.6:1	2.8:1	1.4:1	1:1.4	1:2.8	1:5.6	

7. M: Wireless Flash Shooting with Manual Flash

This describes wireless (multiple shooting) using manual flash. You can shoot with a different flash output setting for each slave unit (firing group). Set all parameters on the master unit.

1 Setting the flash mode to <M>.

2 Setting the number of flash groups.

- When < **MENU** > is displayed, press the Function **Button 2** < **RATIO** > to set the groups to fire.
- The setting changes as follows each time you press the button:
ALL(RATIO OFF)→
A/B(RATIO A: B)→
A/B/C(RATIO A: B: C)

3 Setting flash output.

- Press Function **Button 3** < **Gr** >. Turn the Select Dial to set the flash output of the groups. Press < **SET** > button to confirm.

4 Taking the picture.

- Each group fires at the set flash ratio.

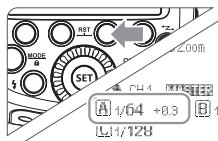
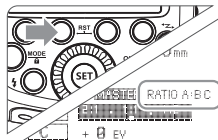

- When ALL < RATIO OFF > is set, set A, B or C as the firing group for the slave units.

- To fire multiple slave units with the same flash output, select ALL < RATIO OFF > in step 2.

Setting <M> Flash Mode

You can directly operate the slave unit to manually set the manual flash or stroboscopic flash.

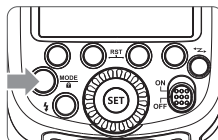

1 Setting the slave unit. (Page 59)

2 Setting flash mode to <M>.

- Press < **MODE** > button so that < **M** > is displayed.
- Set the manual flash output. (Page 54)

8. Multi: Wireless Flash Shooting with Manual Flash



Setting <MULTI> stroboscopic flash.

- Press <MODE> button so that <MULTI> is displayed.
- Setting the stroboscopic flash. (Page 55)

9. Gr: Shooting with a Different Flash Mode for Each Group

When using an EOS digital camera released since 2012, such as the EOS-1DX (except for EOS 1200D), you can shoot with a different flash mode set for each firing group, with up to 5 groups (A/B/C/D/E).

The flash mode that can be set are ①E-TTL II autoflash and ②Manual flash. When the flash mode is ①, exposure is controlled to result in standard exposure for the main subject as a single group. This function is for advanced users who are very knowledgeable and experienced in lighting.

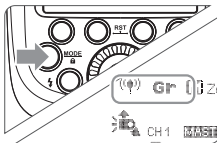
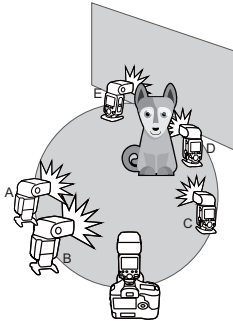

- 1 Set the flash mode to <Gr>**
Press the <MODE> Button and set the flash mode to <Gr>.

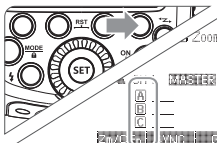

- 2 Set the firing group of the slave units**
 - Operate and set the slave units one by one.
 - While <MENU1> is displayed, press Function Button 3 <Gr> and select <A>, , <C>, <D> or <E>.
 - Set the firing group (A/B/C/D/E) for all the slave units.

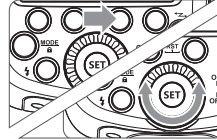
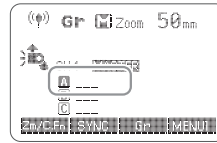

- 3 Set the flash mode**
 - Set the flash mode of each firing group by operating the master unit.
 - While <MENU1> is displayed, press Function Button 3 <Gr> and turn the Select Dial to choose the group.

- Press Function Button 2 <MODE> and select the flash mode of the selected group from <ETTL>, <M> and <--- (OFF)>.
- Repeat step 3 to set the flash mode of all groups.

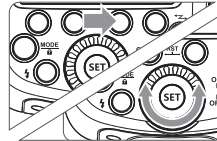
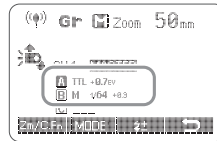

- 4 Set the flash output and flash exposure compensation amount.**
 - While a firing group is selected, press Function Button 3 <±>.
 - Turn the Select Dial to set the flash function corresponding to flash mode, and press <SET> Button to confirm.
 - When using the <M> mode, set the flash output. When using the <ETTL> mode, set the flash exposure compensation amount as required.
 - Repeat step 4 to set the flash function of all groups.
 - Press Function Button 4 <---> to return to the shooting-ready state.

- 5 Take the picture**
 - Each slave unit fires in the respective flash modes set.

Wireless Flash Shooting: Optic Transmission

This product supports wireless flash application and functions as either a master or a slave unit. As a master unit, it can control Canon speedlites e.g. 580EXII, 600EX-RT via wireless. As a slave unit, it can receive wireless signals of Canon speedlites e.g. 580EXII, 600EX-RT and commanders of Canon cameras e.g. 7D/60D/600D.

- You can set up two to three slave groups for E-TTL II autofocus shooting. With E-TTL II autofocus, you can easily create various lighting effects.
- Any flash settings (of flash exposure compensation, high-speed sync, FE lock, FEB, manual flash, Multi flash) on the master unit will be automatically sent to the slave units. So the only thing you need to do is to set the master unit to E-TTL mode without any operation for the slave units at all during the shooting.
- This flash can work in E-TTL autofocus, M manual flash, and Multi strobotoscopic flash modes when set as a master unit.

Positioning and Operation Range

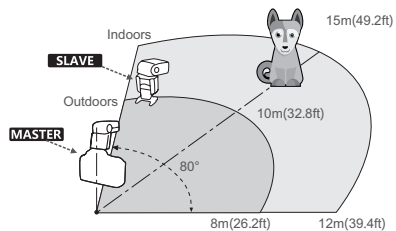

- Even with multiple slave units, the master unit can control all of them via wireless.
- In this user manual, "master unit" refers to the camera flash on a camera and "slave unit" will be controlled by the master unit.

1. Wireless Settings

You can switch between normal flash and wireless flash. For normal flash shooting, be sure to set the wireless setting to OFF.

Master Unit Setting

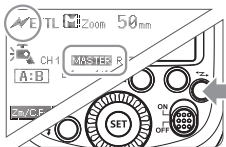

Press <Fn> button so that <Fn> or <MASTER> are displayed on the LCD panel.

Slave Unit Setting

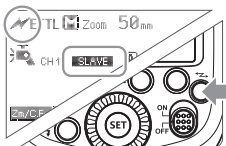

Press <Fn> button so that <Fn> or <SLAVE> are displayed on the LCD panel.

2. Master Unit's Flash OFF

When the master unit is set to OFF, only the slave units will fire a flash.

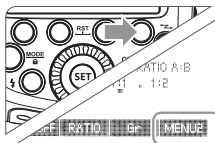

- 1 Press Function **Button 4** so that <MENU> is displayed on the LCD panel.

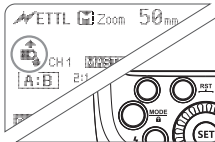

- 2 Press Function **Button 1** <ON/OFF> to control the ON/OFF of the master unit.

<Fn> : The master unit flash firing is ON.

<Fn> : The master unit flash firing is OFF.

3. Setting the Communication Channel

If there are other wireless flash systems nearby, you can change the channel IDs to prevent signal interference. The channel IDs of the master unit and the slave unit(s) must be set to the same.

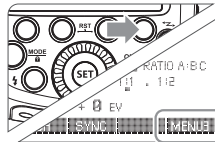

- 1 Press Function **Button 4** so that <MENU> is displayed on the LCD panel.

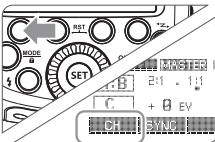

- 2 Press Function **Button 1** so that <CH> is displayed on the LCD panel. Turn the Select Dial to choose a channel ID from 1 to 4.

- 3 Press the <SET> button to confirm.

4. E-TTL: Fully Automatic Wireless Flash Shooting

Using Automatic Wireless Flash with a Single Slave Unit

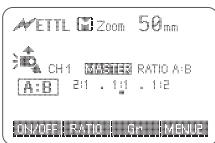

- 1 **Master Unit Setting**
 - Attach a V860IIC camera flash on the camera and set it as the master unit.
 - As a master unit, V860IIC can control Canon speedlites e.g. 580EXII, 600EX-RT via wireless.



2 Slave Unit Setting

- Set the other camera flash as the wireless slave Unit.
- As a slave unit, V860IIC can receive wireless signals of Canon speedlites e.g. 580EXII, 600EX-RT and commanders of Canon cameras e.g. 7D/60D/600D.

3 Check the communication channel.

- If the master unit and slave unit(s) are set to a different channel, set them to the same channel. (Page 68)

4 Position the camera and flashes.

- Position the camera and flashes as the picture shows. (Page 67)

5 Set the master unit's flash mode to <ETTL>.

- Set the master unit's flash mode to <ETTL>.
- For shooting, <ETTL> will automatically be set for the slave unit.
- Set the master unit flash firing as **ON** to fire a flash.

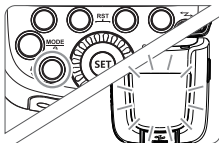

6 Check that the flash is ready.

- Check that the master flash ready indicator is lightened.
- When the slave flash ready indicator is ready, the AF-assist beam lighting area will blink at 1 second intervals.

7 Check the flash operation.

- Press the master unit's Test Button < **⚡** >.
- Then, the slave unit will fire. If not, adjust the slave unit's angle toward the master unit and distance from the master unit.

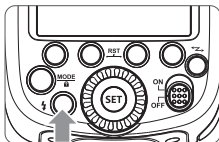

Using Automatic Wireless Flash with Multiple Slave Units

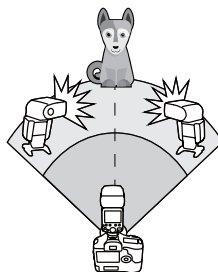

When stronger flash output or more convenient lighting operation is needed, increase the number of slave units and set it as a single slave unit.

To add slave units, use the same steps as setting "automatic wireless flash with a single slave unit". Any flash group can be set (A/B/C).

When the number of slave units is increased and the master unit flash firing is ON, automatic control is implemented to make all groups of flashes fire the same flash output and ensure the total flash output up is to standard exposure.

⚠ The slave unit might be out of order or fire an unwanted flash due to the nearby fluorescent lamp or computer screen.

- 🔧** ● Press the depth-of-field preview button on the camera to fire a modeling flash.
- If the slave unit's auto power off function is workable, press the master unit's test button to power it on. Please note that test firing is unavailable during the camera's regular metering time.
- The effective time of slave auto power off is changeable. (C.Fn-Sv APOT Page 77)
- By making some settings, the auto AF-assist transmitter will not blink after the slave unit's flash ready indicator is lightened. (C.Fn-AF Page 77)

Using Fully Automatic Wireless Flash

The FEC and other settings that set on the master unit will also be appeared on the slave unit automatically. The slave unit does not need any operation. Use the following settings to make wireless flashes according to the same methods with normal flash shooting.

- Flash Exposure Compensation (**±** Page 51)
- Flash Exposure Bracketting (**FEB** Page 52)
- Flash Exposure Lock (Page 52)
- High-Speed Sync (**SYNC** Page 53)
- Manual Flash (Page 54)
- Stroboscopic Flash (Page 55)

- 🔧** Press Function Button 4 so that < **±** >, < **SYNC** > and < **FEB** > are displayed.

About Master Unit

Use two or more master units. By preparing several cameras that with master units flash attached, cameras can be changed in shooting while keeping the same lighting source (slave unit).

5. E-TTL: Use the Wireless Shooting of Flash Ratio

Auto Flash Shooting with Two Slave Unit

Divide the slave units into A and B groups and balance their shooting illumination (flash ratio).

Auto control exposure to make the total output of A and B flash groups up to standard exposure.

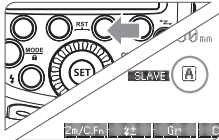

1 Setting the flash groups of slave unit.

- Set the flash as slave unit.
- Press Function Button 3 < **Gr** > and choose <A> or .
- Set one slave unit as <A>, the other as .

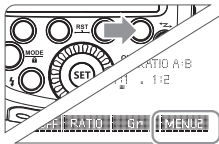

2 Setting < MENU 2 >.

- Step 2 to Step 4 are set on the master unit.
- Press the Function Button 4 on the master unit so that < MENU 2 > is displayed.

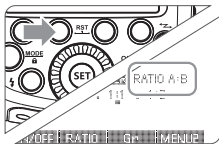

3 Setting <RATIO A:B>.

- Press Function Button 2 < **RATIO** > so that <RATIO A:B> is displayed.

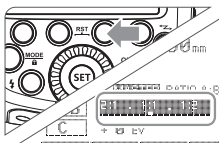

4 Setting flash ratio.

- Press Function Button 3 < **Gr** >.
- Turn the Select Dial to set the amount of flash ratio and press-<SET> button to confirm.

5 Taking the picture.

- The slave units will flash according to the flash ratio.

Auto Flash Shooting with Three Slave Unit

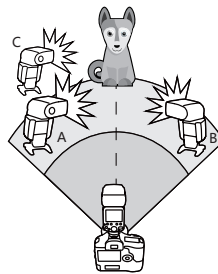

1 Setting the slave group <C>.

- Use the same method of step 1 (Page 71) to set the slave unit of flash group <C>.

2 Setting <RATIO A:B C>.

- Use the same method of step 1 and step 3 (Page 71) to set the master unit as <RATIO A:B C>.

3 Setting flash exposure compensation.

- Use the same method of step 1 (Page 71) to set the slave unit of flash group <C>.
- Press Function Button 2 < **±** >. Turn the Select Dial to set the amount of flash exposure compensation and press-<SET> button to confirm.

About Slave Group Control

Slave Group A



If three slave units are all set to <A> in terms of slave ID, these slave units will be controlled as if they were one camera flash in slave group A.

- When setting < RATIO A:B C >, group A, B and C will fire a flash synchronously; when setting < RATIO A:B >, group C will not fire a flash.
- If shooting under the situation that group C is toward the main shooting subject, over exposure might occurred.
- In some EOS film cameras that support E-TTL autoflash, you cannot perform multiple flash wireless shooting with a flash ratio setting.

- The flash ratio of 8:1 to 1:1 to 1:8 is equivalent to 3:1 to 1:1 to 1:3 (1/2 step increment).
- The details of the flash ratio settings are as follows.

8:1 • 4:1 • 2:1 • 1:1 • 1:2 • 1:4 • 1:8
5.6:1 • 2.8:1 • 1.4:1 • 1:1.4 • 1:2.8 • 1:5.6

6. M: Wireless Flash Shooting with Manual Flash

This describes wireless (multiple shooting) using manual flash. You can shoot with a different flash output setting for each slave unit (firing group). Set all parameters on the master unit.

1 Setting the flash mode to <M>.

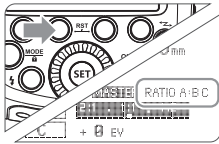

2 Setting the number of flash groups.

- When **<MENU1>** is displayed, press the Function **Button 2** **<RATIO>** to set the groups to fire.
- The setting changes as follows each time you press the button:
ALL(RATIO OFF)→
A/B(RATIO A:B)→
A/B/C(RATIO A:B:C)

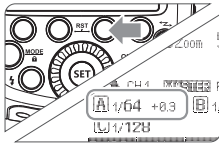

3 Setting flash output.

- Press Function **Button 3** **<Gr>**. Turn the Select Dial to set the flash output of the groups. Press **<SET>** button to confirm.

4 Taking the picture.

- Each group fires at the set flash ratio.

- When ALL **<RATIO OFF>** is set, set A, B or C as the firing group for the slave units.
- To fire multiple slave units with the same flash output, select ALL **<RATIO OFF>** in step 2.

Setting <M> Flash Mode

You can directly operate the slave unit to manually set the manual flash or stroboscopic flash.

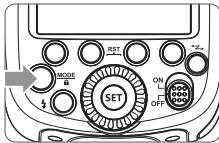

1 Setting the slave unit.

2 Setting flash mode to <M>.

- Press **<MODE>** button so that **<M>** is displayed.
- Set the manual flash output. (Page 54)



7. Multi: Wireless Flash Shooting with Manual Flash



Setting <MULTI> stroboscopic flash.

- Press **<MODE>** button so that **<MULTI>** is displayed.
- Setting the stroboscopic flash. (Page 55)

Other Applications

Wireless Control Function

The flash unit is built in with a Wireless Control Port so that you can wirelessly adjust the power level of the flash and the flash triggering. To control the flash wirelessly, you need a FT-16S remote control set (on-camera and on-flash). Insert its receive end into the Wireless Control Port on the flash and insert the transmit end into the camera hot shoe. Settings made on the hotshoe-mounted transmit and receive ends will be wirelessly communicated to the flash. Then you can press the camera shutter release button to trigger the flash. You can also hold the transmit end at hand to control your off-camera flash.

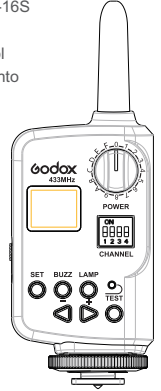

- For full instructions on the use of FT series remote control, see its user manual.

Sync Triggering

The Sync Cord Jack is a $\Phi 2.5\text{mm}$ plug. Insert a trigger plug here and the flash will be fired synchronously with the camera shutter.

Modeling Flash

If the camera has a depth-of-field preview button, pressing it will fire the flash continuously for 1 second. This is called modeling flash. It enables you to see the shadow effects on the subject and the lighting balance. You can fire the modeling flash during wireless or normal flash shooting.

- To avoid overheating and deteriorating the flash head, do not fire the modeling flash for more than 10 consecutive times. If you fire the modeling flash 10 consecutive times, allow at least 10 minutes' break for the camera flash.
- The modeling flash cannot be fired with the EOS 300 and Type-B cameras.

Auto Focus Assist Beam

In poorly-lit or low-contrast shooting environments, the built-in auto focus assist beam will automatically light on to make it easier for autofocus. The beam will light up only when autofocus is difficult and get out as soon as the autofocus becomes correct. If you want to turn off the auto focus assist beam, set the "AF" to "OFF" on the C.Fn settings.

- If you find the auto focus assist beam does not light up, this is because the camera has got a correct autofocus.

Position	Effective Range
Center	0.6~10m / 2.0~32.8 feet
Periphery	0.6~5m / 2.0~16.4 feet

Bounce Flash

By pointing the flash head toward a wall or ceiling, the flash will bounce off the surface before illuminating the subject. This can soften shadows behind the subject for a more natural-looking shot. This is called bounce flash.

To set the bounce direction, hold the flash head and turn it to a satisfying angle.

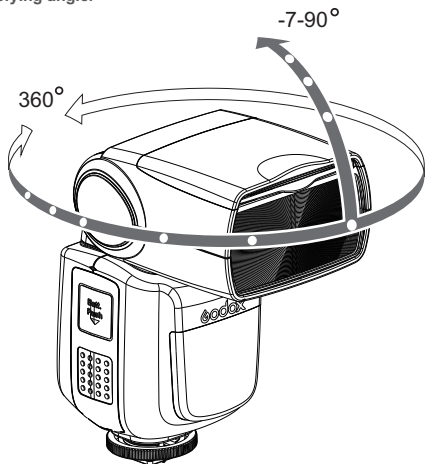

- If the wall or ceiling is too far away, the bounced flash might be too weak and result in underexposure.
- The wall or ceiling should be a plain, white color for high reflectance. If the bounce surface is not white, a color cast may appear in the picture.

Creating a Catchlight

With the catchlight panel, you can create a catchlight in the subject's eyes to add life to the facial expression.

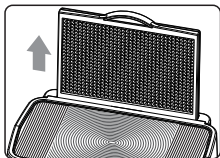

- 1 Point the flash head upward by 90°.
- 2 Pull out the wide panel. The catchlight panel will come out at the same time.

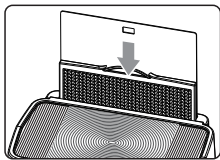

- 3 Push the wide panel back in.
 - Push in only the wide panel.
 - Follow the same procedures as for bounce flash.

- ▲ Point the flash head straight ahead and then upward by 90°. The catchlight will not appear if you swing the flash head left or right.
- For best catchlight effect, stay 1.5m/4.9ft away from the subject.

ZOOM: Setting the Flash Coverage and Using the Wide Panel

The flash coverage can be set automatically or manually. It can be set to match the lens focal length from 20 mm to 200mm. Also, with the built-in wide panel, the flash coverage can be expanded for 14mm wide-angle lenses.

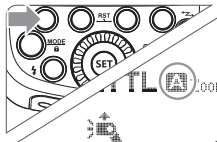

In Manual Zoom mode, press the <ZOOM/C.FN> button.

- Turn the Select Dial to change the flash coverage.
- If <A> is displayed, the flash coverage will be set automatically.

- If you set the flash coverage manually, make sure it covers the lens focal length so that the picture will not have a dark periphery.

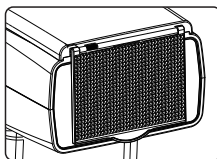

Using the Wide Panel

Pull out the wide panel and place it over the flash head as shown. The flash coverage will then be extended to 14 mm.

- The catchlight panel will come out at the same time. Push the catchlight panel back in.
- The <ZOOM/C.FN> button will not work.



Low Battery Warning

If the battery power is low, < > will appear and blink on the LCD panel. Please replace the battery immediately.

C.Fn: Setting Custom Functions

The following table lists the available and unavailable custom functions of this flash.

C.Fn Custom Functions				
Custom Function Signs	Function	Setting No.	Settings & Description	Custom Functions No.
m/ft	Distance indicator	m	m	C.Fn-00
		ft	feet	
APO	Auto power off	ON	ON	C.Fn-01
		OFF	OFF	
FEB ACL	FEB auto cancel	ON	ON	C.Fn-03
		OFF	OFF	
FEB	FEB order	0 → → → +		C.Fn-04
		→ → 0 → +		
AF	AF-assist beam	ON	ON	C.Fn-08
		OFF	OFF	
Sv APOT	Slave auto power off timer	60min	60min	C.Fn-10
		30min	30min	
BEEP	Beeper	ON	ON	C.Fn-20
		OFF	OFF	
LIGHT	Backlighting time	12sec	Off in 12 sec.	C.Fn-22
		OFF	Always off	
		ON	Always lighting	
LCD	LCD contrast ratio	0-9	10 levels	
ID	Wireless ID	OFF	Off	
		01-99	Choose any figure from 01-99	
Sv LED	Wireless LED Lamp	OFF	Off	
		ON	on	

- Press **<Zm/C.Fn>** Backlight/Custom Setting Button for 2 seconds or longer until C.Fn menu is displayed. The "Ver x.x" in the top-right corner refers to the software version.
- Select the Custom Function No.
 - Turn the Select Dial to select the Custom Function No.
- Change the Setting.
 - Press **<SET>** button and the Setting No. blinks.
 - Turn the Select Dial to set the desired number. Pressing **<SET>** button will confirm the settings.
 - After you set the Custom Function and press **<MODE>** button, the camera will be ready to shoot.
- In the C.Fn states, long press the "Clear" button for 2 seconds until "OK" is displayed on the panel, which means the values in C.Fn can be reset.

Control with the Camera's Menu Screen

If the camera flash is attached to an EOS camera which has a speedlite control function, the flash can be controlled using the camera's menu screen. For the menu operation procedure, refer to your camera's instruction manual.

● Setting Camera Flash Functions

The following flash functions are settable according to different flash modes.

- Flash mode
- Shutter sync (1st/2nd curtain, high speed sync)
- FEB
- Flash exposure compensation
- Flash firing
- Clear camera flash's settings

● Custom Functions of Camera Flash

C.Fn-00, C.Fn-01, C.Fn-03, C.Fn-04, C.Fn-08, C.Fn-10, C.Fn-20, and C.Fn-22.

Clear All Flash Custom Functions

Flash function settings screen

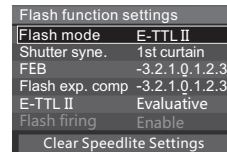

Flash C.Fn settings screen

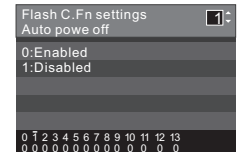

* Screens from the EOS-1D Mark III.

- If flash exposure compensation has already been set with the camera flash, flash exposure compensation cannot be set with the camera. To set it with the camera, the camera flash's flash exposure compensation must be set to zero.
- If any Flash Custom Functions and flash settings other than flash exposure compensation have been set by both the camera and the flash, the latest settings will take effect.

Protection Function

1. Over-Temperature Protection

- To avoid overheating and deteriorating the flash head, do not fire more than 30 continuous flashes in fast succession at 1/1 full power. After 30 continuous flashes, allow a rest time of at least 10 minutes.
- If you fire more than 30 continuous flashes and then fire more flashes in short intervals, the inner over-temperature protection function may be activated and make the recycling time over 10 seconds. If this occurs, allow a rest time of about 10 minutes, and the flash unit will then return to normal.
- When the over-temperature protection is started,  is shown on the LCD display.

Number of flashes that will activate over-temperature protection:

Power Output Level	Number of Flashes
1/1	30
1/2 +0.7	40
1/2 +0.3	50
1/2	60
1/4(+0.3,+0.7)	100
1/8(+0.3,+0.7)	200
1/16(+0.3,+0.7)	300
1/32(+0.3,+0.7)	500
1/64(+0.3,+0.7)	1000
1/128(+0.3,+0.7)	

Number of flashes that will activate over-temperature protection in high-speed sync triggering mode:

Power Output	Times
1/1	15
1/2(+0.3,+0.7);	20
1/4(+0.3,+0.7)	30
1/8(+0.3,+0.7);	
1/16(+0.3,+0.7)	40
1/32(+0.3,+0.7);	
1/64(+0.3,+0.7);	50
1/128(+0.3,+0.7);	

2. Other Protections

The system provides real-time protection to secure the device and your safety. The following lists prompts for your reference:

Prompts on LCD Panel	Meaning
E1	A failure occurs on the recycling system so that the flash cannot fire. Please restart the flash unit. If the problem still exists, please send this product to a maintenance center.
E2	The system gets excessive heat. Please allow a rest time of 10 minutes.
E3	The voltage on two outlets of the flash tube is too high. Please send this product to a maintenance center.
E9	There are some errors occurred during the upgrading process. Please using the correct firmware upgrade method.





Technical Data

Model	V860iIC	
Compatible Cameras	Canon EOS cameras (E-TTL II autoflash)	
Guide No. (1/1 output @ 200mm)	60 (m ISO 100)	190 (feet ISO 100)
Flash Coverage	20 to 200mm (14mm with wide panel)	
	• Auto zoom (Flash coverage set automatically to match the lens focal length and image size)	
	• Manual zoom	
	• Swinging/tilting flash head (bounce flash): 0 to 360° horizontally and -7° to 90° vertically	
Flash Duration	1/300 to 1/20000 seconds	
• Exposure Control		
Exposure control system	E-TTL II autoflash and manual flash	
Flash exposure compensation (FEC)	Manual. FEB: ±3 stops in 1/3 stop increments (Manual FEC and FEB can be combined.)	
FE lock	With <FEL> button or <* > button	
Sync mode	High-speed sync (up to 1/8000 seconds), first-curtain sync, and second-curtain sync	
Multi flash	Provided (up to 100 times, 199Hz)	
• Wireless Flash		
Wireless flash function	Master, Slave, Off	
Controllable slave groups	Optic	3 (A, B, and C)
	2.4G	5 (A, B, C, D and E)
Transmission range (approx.)	Optic	Indoors: 12 to 15 m / 39.4 to 49.2 ft. Outdoors: 8 to 10 m / 26.2 to 32.8 ft.
		Master unit reception angle: ±40° horizontally, ±30° vertically
	2.4G	100m
Channels	Optic	4 (1, 2, 3, and 4)
	2.4G	32 (1~32)
Slave-ready indicator	Two red indicators blink	
Modeling flash	Fired with camera's depth-of-field preview button	
• Auto Focus Assist Beam		
Effective range (approx.)	Center: 0.6~10m / 2.0~32.8 feet Periphery: 0.6~5m / 2.0~16.4 feet	
• Power Supply		
Power source	11.1V/2000mAh Li-ion polymer battery	
Recycle time	< 1.5 seconds. Red LED indicator will light up when the flash is ready.	
Full power flashes	Approx. 650	
Power saving	Power off automatically after approx. 90 seconds of idle operation. (60 minutes if set as slave)	
• Sync Triggering Mode		
Hotshoe, 2.5mm sync line, Wireless control port		
• Color Temperature		
5600±200K		
• Dimensions		
W x H x D	64*76*190 mm	
Weight without battery	430g	
Weight with battery	540g	
2.4G Wireless Frequency Range	2413.0MHz-2464.5MHz	
Max. Transmitting Power of 2.4G Wireless	5dbm	

Troubleshooting

If there is a problem, refer to this Troubleshooting Guide.

The Camera Flash does not fire.

- The camera flash is not attached securely to the camera.
→ Attach the camera's mounting foot securely to the camera.
- The electrical contacts of the Camera Flash and camera are dirty.
→ Clean the contacts.
- <  > or <  H > is not displayed in the view finder of camera.
→ Wait until the flash is fully recycled and the flash ready indicator lights up.
→ If the flash ready indicator lights up, but <  > or <  H > is not displayed in the view finder, check whether this flash unit is securely attached to the camera hotshoe.
→ If the flash ready indicator does not light up after a long wait, check whether the battery power is enough. If the battery power is low, <  > will appear and blink on the LCD panel. Please replace the battery immediately.

The power turns off by itself.

- After 90 seconds of idle operation, auto power off took effect if the flash is set as master.
→ Press the shutter button halfway or press any flash button to wake up.
- After 60 minutes (or 30 minutes) of idle operation, the flash unit will enter sleep mode if it is set as slave.
→ Press any flash button to wake up.

Auto zoom does not work.

- The camera flash is not attached securely to the camera.
→ Attach the camera flash's mounting foot to the camera.

The flash exposure is underexposed or overexposed.

- There was a highly reflective object (e.g. glass window) in the picture.
→ Use FE lock (**FEL**).
- You used high-speed sync.
→ With high-speed sync, the effective flash range will be shorter. Make sure the subject is within the effective flash range displayed.
- You used Manual Flash mode.
→ Set the flash mode to **ETTL** or modify the flash output.

Photos have dark corners or only parts of the target subject are illuminated.

- The focal length of lens exceeds the flash coverage.
→ Check the flash coverage you set. This flash unit has the flash coverage between 20 and 200mm, which fits medium-format cameras. Pull the wide panel out to extend the flash coverage.

Firmware Upgrade

This flash supports firmware upgrade through the USB port. Update information will be released on our official website.

-  USB connection line is not included in this product. The USB port is a standard Micro USB socket. Common USB connection line is applicable.

Compatible Camera Models

This flash unit can be used on the following

Canon EOS series camera models:

1DX	5D Mark III	5D Mark II	6D	7D	60D	50D	40D	30D
650D	600D	550D	500D	450D	400D Digital	1100D	1000D	

-  This table only lists the tested camera models, not all Canon EOS series cameras. For the compatibility of other camera models, a self-test is recommended. Rights to modify this table are retained.

Maintenance

- Shut down the device immediately should abnormal operation be detected.
- Avoid sudden impacts and the product should be dedusted regularly.
- It is normal for the flash tube to be warm when in use. Avoid continuous flashes if unnecessary.
- Maintenance of the flash must be performed by our authorized maintenance department which can provide original accessories.
- This product, except consumables e.g. flash tube, is supported with a one-year warranty.
- Unauthorized service will void the warranty.
- If the product had failures or was wetted, do not use it until it is repaired by professionals.
- Changes made to the specifications or designs may not be reflected in this manual.

FCC Warning

This device complies with part 15 of the FCC Rules. Operation is subject to the following two conditions: (1) This device may not cause harmful interference, and (2) this device must accept any interference received, including interference that may cause undesired operation.

Any Changes or modifications not expressly approved by the party responsible for compliance could void the user's authority to operate the equipment.

Note: This equipment has been tested and found to comply with the limits for a Class B digital device, pursuant to part 15 of the FCC Rules. These limits are designed to provide reasonable protection against harmful interference in a residential installation. This equipment generates uses and can radiate radio frequency energy and, if not installed and used in accordance with the instructions, may cause harmful interference to radio communications. However, there is no guarantee that interference will not occur in a particular installation. If this equipment does cause harmful interference to radio or television reception, which can be determined by turning the equipment off and on, the user is encouraged to try to correct the interference by one or more of the following measures:

- ▶ Reorient or relocate the receiving antenna.
- ▶ Increase the separation between the equipment and receiver.
- ▶ Connect the equipment into an outlet on a circuit different from that to which the receiver is connected.
- ▶ Consult the dealer or an experienced radio/TV technician for help.

***RF warning:**

This equipment complies with FCC radiation exposure limits set forth for an uncontrolled environment. This equipment should be installed and operated with minimum distance 20cm between the radiator & your body.